

This Page Is Inserted by IFW Operations  
and is not a part of the Official Record

## **BEST AVAILABLE IMAGES**

Defective images within this document are accurate representation of  
The original documents submitted by the applicant.

Defects in the images may include (but are not limited to):

- BLACK BORDERS
- TEXT CUT OFF AT TOP, BOTTOM OR SIDES
- FADED TEXT
- ILLEGIBLE TEXT
- SKEWED/SLANTED IMAGES
- COLORED PHOTOS
- BLACK OR VERY BLACK AND WHITE DARK PHOTOS
- GRAY SCALE DOCUMENTS

**IMAGES ARE BEST AVAILABLE COPY.**

**As rescanning documents *will not* correct images,  
please do not report the images to the  
Image Problem Mailbox.**



## INTERNATIONAL APPLICATION PUBLISHED UNDER THE PATENT COOPERATION TREATY (PCT)

<p>(51) International Patent Classification <sup>5</sup> : C07K 15/06, 3/02, 3/20, 13/00, A61K 35/12 A61K 37/12, A01N 63/02, A23J 1/10</p>	A1	<p>(11) International Publication Number: <b>WO 91/02744</b> (43) International Publication Date: 7 March 1991 (07.03.91)</p>
<p>(21) International Application Number: PCT/US90/04745 (22) International Filing Date: 21 August 1990 (21.08.90) (30) Priority data: 397,779 21 August 1989 (21.08.89) US (60) Parent Application or Grant (63) Related by Continuation US 397,779 (CIP) Filed on 21 August 1989 (21.08.89) (71) Applicant (for all designated States except US): CELTRIX LABORATORIES, INC. [US/US]; 2500 Faber Place, Palo Alto, CA 94303 (US). (72) Inventors; and (75) Inventors/Applicants (for US only) : BENTZ, Hanne [DE/ US]; 36125 Toulouse Street, Newark, CA 94560 (US). NATHAN, Ranga [CA/US]; 6104 Robertson Avenue, Newark, CA 94560 (US). ROSEN, David, M. [US/US]; 3655 Shadyhollow Court, San Jose, CA 95148 (US). DASCH, James, R. [US/US]; 3181 Morris Drive, Palo Alto, CA 94303 (US). SEYEDIN, Saeid, M. [IR/US]; 20761 Lowena Court, Saratoga, CA 95070 (US). PIEZ, Karl, A. [US/US]; 1120 Bay Laurel Drive, Menlo Park, CA 94025 (US). OGAWA, Yasushi [US/US]; 310 Faral- lon Avenue, Pacifica, CA 94044 (US). ANDREWS, Wil- liam, H. [US/US]; 780 Fathom Drive, San Mateo, CA 94404 (US). STEPHENSON, Frank, H. [US/US]; 710</p>	<p>Moraga, Apartment C, San Francisco, CA 94122 (US). HEDGPETH, Joel [US/US]; 200 Cresta Vista, San Francisco, CA 94127 (US). (74) Agents: CIOTTI, Thomas, E. et al.; Irell &amp; Manella, 545 Middlefield Road, Suite 200, Menlo Park, CA 94025 (US). (81) Designated States: AT (European patent), AU, BE (Euro- pean patent), CA, CH (European patent), DE (Euro- pean patent)*, DK (European patent), ES (European pa- tent), FR (European patent), GB (European patent), IT (European patent), JP, LU (European patent), NL (Eu- ropean patent), SE (European patent), US. <b>Published</b> <i>With international search report.</i> <i>Before the expiration of the time limit for amending the claims and to be republished in the event of the receipt of amendments.</i></p>	
<p>(54) Title: BONE-SPECIFIC PROTEIN</p> <p>(H<sub>2</sub>N)-Ala-Lys-Tyr-Asn-Lys-Ile-Lys-Ser-Arg-Gly- Ile-Lys-Ala-Asn-R<sup>1</sup>-Phe-Lys-Lys-Leu-R<sup>2</sup>- Asn-Leu-R<sup>3</sup>-Phe-Leu-Tyr-Leu-Asp-His-Asn- Ala-Leu-Glu-Ser-Val-Pro-Leu-Asn-Leu-Pro- Glu-Ser-Leu-Arg-Val-Ile-His-Leu-Gln-Phe- Asn-Asn-Ile-R<sup>4</sup>-Ser-Ile-Thr-Asp-Asp-Thr- Phe-Cys-Lys-Ala-Asn-Asp-Thr-Ser-Tyr-Ile- Arg-Asp-Arg-Ile-Glu-Glu-Ile-Arg-Leu-Glu- Gly-Asn-Pro-R<sup>5</sup>-R<sup>6</sup>-Leu-Gly-Lys-His-Pro- Asn-Ser-Phe-Ile-Cys-Leu-Lys-Arg-Leu-Pro- Ile-Gly-Ser-Tyr-R<sup>7</sup>-(COOH),</p> <p>(57) Abstract</p> <p>Proteins, having sequence (I) where R<sup>1</sup> is Ala ou Thr, R<sup>2</sup> is Asn or His, R<sup>3</sup> is Thr or Ser, R<sup>4</sup> is Ala or Thr, R<sup>5</sup> is Ile or Val, R<sup>6</sup> is Val or Ile and R<sup>7</sup> is Phe or Ile, is disclosed. These proteins are present in osteoblasts and osteocytes and may be used as markers to follow bone and/or cartilage metabolism.</p>	<p>DEMINERALIZED BONE POWDER (0.5 N HCL)</p> <p>↓</p> <p>4 M GUANIDINE HYDROCHLORIDE EXTRACT</p> <p>↓</p> <p>SEPHACRYLS - 200 (20 - 36KD MW)</p> <p>↓</p> <p>CM - CELLULOSE (10 - 150 mM NaCl)</p> <p>↓</p> <p>CONCANAVALIN - A (0.5 M METHYL α - D - MANNOPYRANOSIDE)</p> <p>↓</p> <p>HEPARIN - SEPHAROSE (0.1 - 0.5 M NaCl)</p> <p>↓</p> <p>C 18 - REVERSED PHASE - HPLC (42 - 45% ACETONOTRILE)</p>	

## DESIGNATIONS OF "DE"

Until further notice, any designation of "DE" in any international application whose international filing date is prior to October 3, 1990, shall have effect in the territory of the Federal Republic of Germany with the exception of the territory of the former German Democratic Republic.

### *FOR THE PURPOSES OF INFORMATION ONLY*

Codes used to identify States party to the PCT on the front pages of pamphlets publishing international applications under the PCT.

AT	Austria	ES	Spain	MC	Monaco
AU	Australia	FI	Finland	MG	Madagascar
BB	Barbados	FR	France	ML	Mali
BE	Belgium	GA	Gabon	MR	Mauritania
BF	Burkina Faso	GB	United Kingdom	MW	Malawi
BG	Bulgaria	GR	Greece	NL	Netherlands
BJ	Benin	HU	Hungary	NO	Norway
BR	Brazil	IT	Italy	PL	Poland
CA	Canada	JP	Japan	RO	Romania
CF	Central African Republic	KP	Democratic People's Republic of Korea	SD	Sudan
CG	Congo	KR	Republic of Korea	SE	Sweden
CH	Switzerland	LI	Liechtenstein	SN	Senegal
CM	Cameroon	LK	Sri Lanka	SU	Soviet Union
DE	Germany	LU	Luxembourg	TD	Chad
DK	Denmark			TC	Togo
				US	United States of America

-1-

5

BONE-SPECIFIC PROTEINDescriptionTechnical Field

10           The present invention relates to protein chemistry. More particularly, it relates a protein that occurs specifically in bone, antibodies to such proteins, and immunoassays for detecting such proteins.

15 Background Art

          Others have fractionated bone in an attempt to identify proteins which can stimulate the formation of new bone when placed in contact with living systems. (Urist, M. R., Clin Orthop (1968) 56:37; Science (1965) 150:893; 20 Reddi, A. H., et al., Proc Natl Acad Sci (USA) (1972) 69:1601.) A "bone morphogenic protein" (BMP) was extracted from demineralized bone using urea or guanidine hydrochloride and reprecipitated according to the disclosures in U.S. Patents Nos. 4,294,753 and 4,455,256 25 to Urist. Urist subsequently reported (Urist, M. R., Clin Orthop Rel Res (1982) 162:219) that ion exchange purification of this crude protein mixture yielded an activity which was unadsorbed to carboxymethyl cellulose resin (CMC) at pH 4.8. Urist's reports in Science (1983) 30 220:680-685, Proc Natl Acad Science (USA) (1984) 81:371-375, and U.S. Pat. No. 4,789,732 describe BMPs having molecular weights of 17,500 and 18,500 daltons. Urist's patent publication, EPA Publication No. 0212474, describes BMP fragments of 4,000 to 7,000 daltons obtained by 35 limited proteolysis of BMP.

-2-

U.S. Patent No. 4,608,199 describes a bone-derived protein of 30,000-32,000 daltons. The protein is described as being water soluble and having no affinity for concanavalin A (ConA).

5 WO 88/00205 reports four proteins, designated BMP-1, BMP-2 Class I, BMP-2 Class II and BMP-3, that are alleged to have osteogenic activity by themselves or in combination with other factors. Sequences are provided for each of these proteins which show no homology to the  
10 sequence (see below) of the protein of the present invention.

Commonly owned U.S. 4,434,094 reported the partial purification of a bone generation-stimulating, bone-derived protein by extraction with chaotropic agents,  
15 fractionation on anion and cation exchange columns, and recovery of the activity from a fraction adsorbed to CMC at pH 4.8. This new protein fraction was termed "osteogenic factor" (OF) and was characterized as having a  
20 molecular weight below about 30,000 daltons.

Commonly owned U.S. Patent No. 4,774,332 describes two proteins that were purified to homogeneity using a purification procedure that is similar in part to that disclosed in U.S. 4,434,094. Those two proteins eluted from CMC at about a 150-200 mM NaCl gradient.  
25 These two proteins were originally called cartilage-inducing factor (CIF) A and CIF B. CIF A was subsequently found to be identical to a previously identified protein now called transforming growth factor beta1 (TGF-beta1). CIF B has been found to be a novel form of TGF-beta and is  
30 now known as TGF-beta2. These proteins and homologous proteins exhibiting similar activity are collectively referred to as TGF-beta.

Commonly owned U.S. Patent No. 4,627,982 concerns a partially purified bone-inducing factor present  
35 in the CMC-bound fraction of U.S. 4,434,094 that elutes in the portion of the NaCl gradient below that in which the

-3-

major portions of TGF-beta1 and TGF-beta2 elute (i.e., below about 150 mM NaCl). The present invention relates to the identification of an ingredient of that fraction.

## 5 Disclosure of the Invention

One aspect of the invention is a substantially pure polypeptide that is found in bone and has the following sequence:

10

(H<sub>2</sub>N)-Ala-Lys-Tyr-Asn-Lys-Ile-Lys-Ser-Arg-Gly-  
 Ile-Lys-Ala-Asn-R<sup>1</sup>-Phe-Lys-Lys-Leu-R<sup>2</sup>-  
 Asn-Leu-R<sup>3</sup>-Phe-Leu-Tyr-Leu-Asp-His-Asn-  
 Ala-Leu-Glu-Ser-Val-Pro-Leu-Asn-Leu-Pro-  
 15 Glu-Ser-Leu-Arg-Val-Ile-His-Leu-Gln-Phe-  
 Asn-Asn-Ile-R<sup>4</sup>-Ser-Ile-Thr-Asp-Asp-Thr-  
 Phe-Cys-Lys-Ala-Asn-Asp-Thr-Ser-Tyr-Ile-  
 Arg-Asp-Arg-Ile-Glu-Glu-Ile-Arg-Leu-Glu-  
 Gly-Asn-Pro-R<sup>5</sup>-R<sup>6</sup>-Leu-Gly-Lys-His-Pro-  
 20 Asn-Ser-Phe-Ile-Cys-Leu-Lys-Arg-Leu-Pro-  
 Ile-Gly-Ser-Tyr-R<sup>7</sup>-(COOH),

20

where R<sup>1</sup> is Ala or Thr, R<sup>2</sup> is Asn or His, R<sup>3</sup> is Thr or Ser, R<sup>4</sup> is Ala or Thr, R<sup>5</sup> is Ile or Val, R<sup>6</sup> is Val or Ile  
 25 and R<sup>7</sup> is Phe or Ile, and substantially pure polypeptides that are and substantially homologous thereto.

Deglycosylated analogs of the above-described polypeptides are another aspect of the invention.

Further aspects of the invention are recombinant  
 30 materials (i.e., recombinant DNA, recombinant vectors, and recombinant cells or microorganisms) and processes for producing the polypeptides of the invention, antibodies specific to the polypeptides, and immunoassays for the polypeptides.

35

-4-

Brief Description of the Drawings

In the drawings:

Figure 1 is a flow chart of the process that was used to isolate the bovine species of the bone-specific protein of the invention from demineralized bovine bone.

Figure 2 is a graph of the optical densities (absorbances at 280 nm) of the gel filtration fractions of the gel filtration fractions of the example (¶C).

Figure 3 is a graph of the optical densities (absorbances at 280 nm) of eluate fractions from the preparative ion exchange chromatography of the example (¶D).

Figure 4 is a graph of the optical densities (absorbances at 280 nm) of eluate fractions from the cross-linked ConA chromatography step of the example (¶E);

Figure 5 is a graph of the optical densities (absorbances at 280 nm) of eluate fractions from the heparin-sepharose chromatography step of the example (¶F);

Figure 6 is a graph of the optical densities (absorbances at 230 nm) of the gradient fractions from the C18-RP-HPLC chromatography step of the example (¶G);

Figure 7 is a table showing results of amino acid sequencing of the bovine isolate of the invention and locations of the sequenced fragments in the overall sequence.

Figure 8 is a photograph of an autoradiograph of SDS-PAGE analyses of the purified bovine protein that are described in the example (¶H) (lanes A and C show glycosylated protein; lanes B and D show enzymatically deglycosylated protein).

Figure 9 is a schematic diagram illustrating the structure of the bovine gene that encodes the mature bovine species of the protein of the invention. Various restriction sites are indicated.

-5-

Figure 10 is a restriction map of the region of the human gene that encodes the human species of the protein.

Figure 11, in parts A-E, shows the DNA sequence and deduced amino acid sequence of the mature human species of the protein of the invention in comparison with the sequences of the bovine gene and protein. Part A shows the preliminary unconfirmed sequence of a putative "amino terminal" precursor exon of the human gene for the prepropolypeptide. The extent of this exon has not been determined. Bases of uncertain identity in the DNA sequence are represented by numbers. The signal sequence indicated in the figure is putative and was identified by the von Heijne algorithm. Part B shows the sequence of another precursor exon, designated -1, that is downstream of the amino terminal exon and upstream of the exon that encodes the amino terminal of the mature protein. Parts C-E show the sequences of exons 1-3 which encode the mature protein. Asterisks designate points of identity between the bovine and human DNA sequences. Amino acid numbering is relative to the mature sequence with the first amino acid thereof designated "1". Consensus 3' and 5' exon splice sites are indicated by YYYYYYYYYYNYAG and JAGGTRAGT, respectively.

Figure 12 is a schematic diagram of the mammalian expression vector phOIF18 which contains the human gene that encodes the human species of the invention protein.

### 30 Modes of Carrying Out the Invention

#### Isolation of Protein from Bone

It is believed that the protein of the present invention has been highly conserved among mammalian species--i.e., corresponding proteins from different mammalian species (herein called "species analogs") will



-6-

have substantially homologous amino acid sequences that vary from the bovine or human proteins described herein, if at all, in one or more amino acid residue additions, deletions or substitutions and/or substantially similar glycosylation patterns. The amino acid sequences of "substantially homologous" proteins will usually be at least 50% identical, more usually at least 80% identical, and preferably at least 90% identical to the bovine/human amino acid sequence described herein. Such proteins may be derived from bone or other tissues of diverse mammalian origin or synthesized using recombinant DNA procedures. The term is intended to include muteins or analogs of the native protein that are altered in manners known in the art, such as by substitution of cysteines with neutral (uncharged) amino acids to avoid improper disulfide bonding, by substitution or elimination of residues in the asparagine-linked glycosylation sites of the proteins to alter glycosylation patterns, by substitution of methionines to make the molecules less susceptible to oxidation, by conservative substitution of other residues, by chemical modification of one or more residues, by substitution with nonnatural amino acids or by elimination or alteration of side-chain sugars. The source of protein prepared by purification from native sources is advantageously porcine or bovine long bone because of its ready availability.

The process for isolating the protein from bone is as follows. The bone is first cleaned using mechanical or abrasive techniques, fragmented, and further washed with, for example, dilute aqueous acid preferably at low temperature. The bone is then demineralized by removal of the calcium phosphates in their various forms, usually by extraction with stronger acid. These techniques are understood in the art, and are disclosed, for example, in U.S. 4,434,094. The resulting preparation, a

-7-

demineralized bone, is the starting material for the preparation of the protein from native sources.

The initial extraction is designed to remove the nonfibrous (e.g., noncollagenous) proteins from the demineralized bone. This can be done with the use of chaotropic agents such as guanidine hydrochloride (at least about 4 molar), urea (8 molar) plus salt, or sodium dodecylsulfate (at least about 1% by volume) or such other chaotropic agents as are known in the art (Termine et al., J Biol Chem (1980) 255:9760-0772; and Sajera and Hascall, J Biol Chem (1969) 244:77-87 and 2384-2396). The extraction is preferably carried out at reduced temperatures to reduce the likelihood of digestion or denaturation of the extracted protein. A protease inhibitor may be added to the extractant, if desired. The pH of the medium depends upon the extractant selected. The process of extraction generally takes on the order of about 4 hr to 1 day.

After extraction, the extractant may be removed by suitable means such as dialysis against water, preceded by concentration by ultrafiltration if desired. Salts can also be removed by controlled electrophoresis, or by molecular sieving, or by any other means known in the art. It is also preferred to maintain a low temperature during this process so as to minimize denaturation of the proteins. Alternatively, the extractant chaotropic agent need not be removed, but rather the solution need only be concentrated, for example, by ultrafiltration.

The extract, dissolved or redissolved in chaotropic agent, is subjected to gel filtration to obtain fractions of molecular weight in the range of about 20,000 to 36,000 daltons. Gel sizing is done using standard techniques, preferably on a Sephacryl S-200 column at room ( $10^{\circ}\text{C}$ - $25^{\circ}\text{C}$ ) temperature.

The sized fraction is then subjected to ion exchange chromatography using CMC at approximately pH 4.5-5.2 preferably about 4.8, in the presence of a nonionic

-8-

chaotropic agent such as 6M urea. Other cation exchangers may be used, including those derived from polyacrylamide and cross-linked dextran; however cellulosic cation exchangers are preferred. Of course, as in any ion exchange procedure, the solution must be freed of competing ions before application to the column. The protein is adsorbed on the column and is eluted in an increasing salt concentration gradient in the range of about 10 mM to about 150 mM. This fraction is designated "CMB-1" for convenience.

CMB-1 is lyophilized and the dry CMB-1 is dissolved in aqueous sodium deoxycholate (DOC), pH 8.0. This solution is affinity chromatographed on an equilibrated column of ConA cross-linked to resin. The ConA-bound material is eluted from the resin with aqueous DOC containing a displacement carbohydrate. This fraction is designated "CAB-1" for convenience.

CAB-1 is reequilibrated for heparin-sepharose chromatography by desalting on a GH-25 column equilibrated on heparin-sepharose buffer, 6M urea, 0.1M NaCl, 50 mM Tris-HCl pH 7.2. The desalted fraction is loaded onto a heparin-sepharose column. After washing, bound material is eluted from the column using the same buffer at a 0.5M NaCl salt concentration. The resulting eluate is designated "HSB-1" for convenience.

HSB-1 is diluted and adjusted to pH 2 and loaded onto a C18-RP-HPLC column. Bound proteins were gradient eluted from the column using a solvent consisting of 90% acetonitrile in 0.1% aqueous TFA (Solvent B). The protein of the invention elutes at approximately 47-50% of solvent B (42-45% acetonitrile) by volume.

Proteins eluted by the C18 chromatography were iodinated by the chloramine-T method. Analysis of the fraction by SDS-PAGE and autoradiography shows a major broad band at 20,000 to 28,000 daltons comprising the

-9-

protein. The "smearing" of the protein is believed to  
mainly be the result of heterogeneity in the glycosylation  
of the molecule or perhaps variable post-translational  
modification or proteolytic degradation. After enzymatic  
5 or chemical deglycosylation, SDS-PAGE analysis of the  
protein gives a single band of approximately 10,000  
daltons. Reduction of the deglycosylated protein with  
dithiothreitol does not affect its migration.

Initial amino acid sequence analysis of the  
10 glycosylated protein so isolated from bovine bone yielded  
the following internal sequence in the N-terminal portion  
of the protein:

-Lys-Tyr-Asn-Lys-Ile-Lys-Ser-Arg-Gly-Ile-Lys-  
15 Ala-Asn-Thr-Phe-Lys-Lys-Leu-His-Asn-Leu-Ser-Phe-X-Thr-Thr-  
Asp-His-Asn-Ala-Leu-Glu-

The initial amino acid (Lys) in the above sequence is  
nearest to the N-terminal. Initially, the nature of the  
20 signal obtained for the residue designated X did not  
permit this residue to be identified. Repeated sequencing  
of the entire peptide and sequencing of oligopeptides  
generated from endoproteinase Lys-C (an enzyme that  
cleaves proteins at Lys residues) and endoproteinase Glu-C  
25 (an enzyme that cleaves proteins at Glu residues) digests  
have revealed that the above sequence is preceded by an  
Ala residue which is the N-terminus, that the residue  
designated X is Leu, that the second Thr residue (the 26th  
residue in the above sequence) was incorrect and that this  
30 residue is actually a Leu residue, and that the isolate  
consists of a protein of approximately 106 amino acids.  
Figure 7 provides a summary of these sequence analyses.  
The symbol "CHO" designates a carbohydrate substituent.  
The symbol "COOH" represents a carboxyl group and  
35 designates the carboxy terminus. The first column (on the

-10-

left) provides the sequence analysis of the N-terminal fragment described above. The second, fourth, and sixth columns give the sequences of three major Lys-C fragments of the isolate. The third and fifth columns give the sequences of two Glu-C fragments.

Subsequent isolation of the gene for this protein confirmed the sequence shown in Figure 7 with the sole exception that the deduced sequence lacked the Asp residue at the carboxy terminal. Accordingly, the sequence for the native bovine protein is as follows:

(H<sub>2</sub>N)-Ala-Lys-Tyr-Asn-Lys-Ile-Lys-Ser-Arg-Gly-Ile-Lys-Ala-Asn-Thr-Phe-Lys-Lys-Leu-His-Asn-Leu-Ser-Phe-Leu-Tyr-Leu-Asp-His-Asn-Ala-Leu-Glu-Ser-Val-Pro-Leu-Asn-Leu-Pro-Glu-Ser-Leu-Arg-Val-Ile-His-Leu-Gln-Phe-Asn-Asn-Ile-Thr-Ser-Ile-Thr-Asp-Asp-Thr-Phe-Cys-Lys-Ala-Asn-Asp-Thr-Ser-Tyr-Ile-Arg-Asp-Arg-Ile-Glu-Glu-Ile-Arg-Leu-Glu-Gly-Asn-Pro-Val-Ile-Leu-Gly-Lys-His-Pro-Asn-Ser-Phe-Ile-Cys-Leu-Lys-Arg-Leu-Pro-Ile-Gly-Ser-Tyr-Ile-(COOH),

The sequence of the corresponding human protein was determined by obtaining the human gene using DNA probes based on the bovine DNA sequence, sequencing the human gene and deducing the amino acid sequence of the protein encoded thereby. The sequence of the human protein was found to be as follows.

(H<sub>2</sub>N)-Ala-Lys-Tyr-Asn-Lys-Ile-Lys-Ser-Arg-Gly-Ile-Lys-Ala-Asn-Ala-Phe-Lys-Lys-Leu-Asn-Asn-Leu-Thr-Phe-Leu-Tyr-Leu-Asp-His-Asn-Ala-Leu-Glu-Ser-Val-Pro-Leu-Asn-Leu-Pro-Glu-Ser-Leu-Arg-Val-Ile-His-Leu-Gln-Phe-

-11-

Asn-Asn-Ile-Ala-Ser-Ile-Thr-Asp-Asp-Thr-  
Phe-Cys-Lys-Ala-Asn-Asp-Thr-Ser-Tyr-Ile-  
Arg-Asp-Arg-Ile-Glu-Glu-Ile-Arg-Leu-Glu-  
Gly-Asn-Pro-Ile-Val-Leu-Gly-Lys-His-Pro-  
5 Asn-Ser-Phe-Ile-Cys-Leu-Lys-Arg-Leu-Pro-  
Ile-Gly-Ser-Tyr-Phe-(COOH),

A comparison of the human sequence with the  
bovine sequence shows that there are seven differences at  
10 positions 15, 20, 23, 54, 84, 85 and 105 of the sequence.  
Accordingly, at least the residues at those positions may  
be interchanged. It is possible, of course, that  
sequences of other mammalian or avian species may exhibit  
other differences.

15 In the course of obtaining the genes for the  
mature bovine and human proteins it was discovered that  
the genes each encode a precursor segment. Portions of  
the precursor segments for the bovine and human proteins  
are shown in Figure 11, parts A and B. Accordingly, it is  
20 believed that the protein occurs as a prepropolypeptide  
and is processed into the mature protein defined by the  
sequences indicated above. Polypeptides comprising the  
mature protein sequence and including a portion or all of  
the precursor segments are intended to be within the scope  
25 of the invention.

The invention provides the protein in  
substantially pure form in which it is essentially free of  
other molecules with which it is associated in nature. In  
this regard, the term "substantially pure" intends a  
30 composition containing less than about 30% by weight  
contaminating protein, preferably less than about 10%  
contaminating protein, and most preferably less than about  
5% by weight contaminating protein. The term  
"substantially pure" is used relative to proteins with  
35 which the protein is associated in nature and is not  
intended to exclude compositions in which the protein is

-12-

admixed with nonproteinaceous carriers or vehicles, or proteinaceous carriers or vehicles, provided other protein(s) with which it is associated naturally are absent. The invention also provides the protein in novel  
5 partially glycosylated or totally deglycosylated forms (both of which are referred to herein as "deglycosylated").

Based on the above amino acid sequences, oligonucleotide probes which contain the codons for a portion or all of the determined amino acid sequences are  
10 prepared and used to screen DNA libraries for substantially homologous genes that encode related proteins. The homologous genes may be from other species of mammals or animals (e.g., avians) or may represent  
15 other members of a family of related genes. The basic strategies for preparing oligonucleotide probes and DNA libraries, as well as their screening by nucleic acid hybridization, are well known to those of ordinary skill in the art. See, e.g., DNA CLONING: VOLUME I (D.M. Glover  
20 ed. 1985); NUCLEIC ACID HYBRIDIZATION (B.D. Hames and S.J. Higgins eds. 1985); OLIGONUCLEOTIDE SYNTHESIS (M.J. Gate ed. 1984); T. Maniatis, E.F. Frisch & J. Sambrook, MOLECULAR CLONING: A LABORATORY MANUAL (1982).

First, a DNA library is prepared. Since the  
25 initially identified protein was bovine, it was logical to probe a bovine library first, find full length clones and use the full length bovine clones to probe libraries of other mammalian species to identify the protein gene (and thus the amino acid sequences) of other species. The  
30 library can consist of a genomic DNA library. Bovine and human genomic libraries are known in the art. See, e.g., Lawn et al., Cell (1978) 15:1157-1174. DNA libraries can also be constructed of cDNA prepared from a poly-A RNA (mRNA) fraction by reverse transcription. See, e.g., U.S.  
35 Patent Nos. 4,446,235; 4,440,859; 4,433,140;

-13-

4,431,740; 4,370,417; 4,363,877. The mRNA is isolated from an appropriate cell line or tissue that expresses the factor. Libraries from cells involved in bone formation (e.g., osteoblasts) or from osteotumors (e.g., osteosarcoma lines) are likely sources to probe for the nucleic acids that encode the protein. cDNA (or genomic DNA) is cloned into a vector suitable for construction of a library. A preferred vector is a bacteriophage vector, such as phage lambda. The construction of an appropriate library is within the skill of the art.

Once the library is constructed, oligonucleotides to probe the library are prepared and used to isolate the desired genes. The oligonucleotides are synthesized by any appropriate method. The particular nucleotide sequences selected are chosen so as to correspond to the codons encoding the known amino acid sequences of the protein. Since the genetic code is redundant, it will often be necessary to synthesize several oligonucleotides to cover all, or a reasonable number, of the possible nucleotide sequences which encode a particular region of a protein. Thus, it is generally preferred in selecting a region upon which to base the probes, that the region not contain amino acids whose codons are highly degenerate. It may not be necessary, however, to prepare probes containing codons that are rare in the mammal from which the library was prepared. In certain circumstances, one of skill in the art may find it desirable to prepare probes that are fairly long, and/or encompass regions of the amino acid sequence which would have a high degree of degeneracy in corresponding nucleic acid sequences, particularly if this lengthy and/or degenerate region is highly characteristic of the protein. Probes covering the complete gene, or a substantial part of the genome, may also be appropriate, depending upon the expected degree of homology. Such would be the case, for example, if a cDNA of a bovine protein was used to screen



-14-

a human gene library for the corresponding human protein gene. It may also be desirable to use two probes (or sets of probes), each to different regions of the gene, in a single hybridization experiment. Automated oligonucleotide synthesis has made the preparation of large families of probes relatively straightforward. While the exact length of the probe employed is not critical, generally it is recognized in the art that probes from about 14 to about 20 base pairs are usually effective. Longer probes of about 25 to about 60 base pairs are also used.

The selected oligonucleotide probes are labeled with a marker, such as a radionucleotide or biotin using standard procedures. The labeled set of probes is then used in the screening step, which consists of allowing the single-stranded probe to hybridize to isolated ssDNA from the library, according to standard techniques. Either stringent or permissive hybridization conditions could be appropriate, depending upon several factors, such as the length of the probe and whether the probe is derived from the same species as the library, or an evolutionarily close or distant species. The selection of the appropriate conditions is within the skill of the art. See generally, NUCLEIC ACID HYBRIDIZATION, supra. The basic requirement is that hybridization conditions be of sufficient stringency so that selective hybridization occurs; i.e., hybridization is due to a sufficient degree of nucleic acid homology (e.g., at least about 75%), as opposed to nonspecific binding. Once a clone from the screened library has been identified by positive hybridization, it can be confirmed by restriction enzyme analysis and DNA sequencing that the particular library insert contains a gene for the protein.

Alternatively, a DNA coding sequence for a protein can be prepared synthetically from overlapping oligonucleotides whose sequence contains codons for the amino acid sequence of the protein. Such oligonucleotides

-15-

are prepared by standard methods and assembled into a complete coding sequence. See, e.g., Edge, Nature (1981) 292:756; Nambair et al., Science (1984) 223:1299; Jay et al., J Biol Chem (1984) 259:6311.

5           Accordingly recombinant polynucleotides that encode the polypeptides may be prepared and isolated by one or more of the above described techniques. The term "recombinant polynucleotide" as used herein denotes a polynucleotide of genomic, cDNA, semisynthetic or  
10 synthetic origin which, by virtue of its origin or manipulation (1) is not associated with all or a portion of the nucleic acid with which it is associated in nature or in the form of a library, (2) is linked to a polynucleotide to which it is not linked in nature or in a  
15 library, or (3) is not found in nature or in a library.

The DNA sequence coding for the protein can be cloned in any suitable vector, identified, isolated, and thereby maintained in a composition substantially free of vectors that do not contain the coding sequence of the  
20 protein (e.g., other library clones). Numerous cloning vectors are known to those of skill in the art, and the selection of an appropriate cloning vector is a matter of choice. Examples of recombinant DNA vectors for cloning and the host cells which they transform include  
25 bacteriophage lambda (E. coli), pBR322 (E. coli), pACYC177 (E. coli), pKT230 (gram-negative bacteria), pGV1106 (gram-negative bacteria), pLAFR1 (gram-negative bacteria), pME290 (non-E. coli gram-negative bacteria), pHV14 (E. coli and Bacillus subtilis), pBD9 (Bacillus),  
30 pIJ61 (Streptomyces), pUC6 (Streptomyces), actinophage C31 (Streptomyces), YIp5 (yeast), YCp19 (yeast), and bovine papilloma virus (mammalian cells). See generally, DNA CLONING: VOLUMES I & II, supra; MOLECULAR CLONING: A LABORATORY MANUAL, supra.

35           In one embodiment of the present invention, the coding sequence for gene encoding the protein is placed

-16-

under the control of a promoter, ribosome binding site (for bacterial and eucaryotic expression), and optionally an operator (collectively referred to herein as "control sequences"), so that the DNA sequence encoding the protein (referred to herein as the "coding" sequence) is transcribed into RNA and the RNA translated into protein in the host cell transformed by the vector. The coding sequence may or may not contain a signal peptide or leader sequence. The determination of the point at which the precursor protein begins and the signal peptide ends is easily determined from the N-terminal amino acid sequence of the precursor protein. The protein can also be expressed in the form of a fusion protein, wherein a heterologous amino acid sequence is expressed at the N-terminal. See, e.g., U.S. Patents Nos. 4,431,739; 4,425,437.

The recombinant vector is constructed so that the protein coding sequence is located in the vector with the appropriate control sequences, the positioning and orientation of the protein coding sequence with respect to the control sequences being such that the coding sequence is transcribed under the control of the control sequences (i.e., by RNA polymerase which attaches to the DNA molecule at the control sequences). The control sequences may be ligated to the coding sequence prior to insertion into a vector, such as the cloning vectors described above. Alternatively, the coding sequence can be cloned directly into an expression vector which already contains the control sequence and an appropriate restriction site downstream from control sequences. For expression of the protein coding sequence in procaryotes and yeast, the control sequences will be heterologous to the coding sequence. If the selected host cell is a mammalian cell, the control sequences can be heterologous or homologous to the protein coding sequence, and the coding sequence can be genomic DNA, cDNA or synthetic DNA. Either genomic or

-17-

cDNA coding sequence may be expressed in yeast. If secretory expression in eukaryotic cells is necessary or desirable, sequences such as the yeast alpha factor signal sequence or other sequences that direct secretion are included in the control sequence. If glycosylation similar to the native molecule is desired, the gene may be expressed in yeast or mammalian cells (COS, CHO, or CV-1 cells) using vectors and procedures known in the art. A number of procaryotic expression vectors are known in the art. See, e.g., U.S. Patent Nos. 4,440,859; 4,436,815; 4,431,740; 4,431,739; 4,428,941; 4,425,437; 4,418,149; 4,411,994; 4,366,246; 4,342,832. See also British Patent Specifications GB 2,121,054; GB 2,008,123; GB 2,007,675; and European Patent Specification 103,395. Yeast expression vectors are known in the art. See, e.g., U.S. Patent Nos. 4,446,235; 4,443,539; 4,430,428. See also European Patent Specifications 103,409; 100,561; and 96,491.

Recombinant protein can be produced by growing host cells transformed by the expression plasmid described above under conditions whereby the protein is produced. The protein is then isolated from the host cells and purified. If the expression system secretes protein into growth media, the protein can be purified directly from cell-free media. If the recombinant protein is not secreted, it is isolated from cell lysates. The selection of the appropriate growth conditions and recovery methods are within the skill of the art or are apparent from the recovery methods used to isolate the native proteins. The recombinant protein may be recovered by affinity chromatography using the antibodies produced in accordance with the invention. Recombinant protein may be unglycosylated or have a different glycosylation pattern than the native molecule depending upon the host that is used to produce it. The proteins are useful for making

-18-

antibodies that recognize sequential epitopes of the protein, and are useful as bone markers.

5           Either native, deglycosylated, or synthetic (recombinant) protein can be used to produce antibodies, both polyclonal and monoclonal. The term "antibody" is intended to include whole Ig of any isotype or species as well as antigen binding fragments, chimeric constructs and single chain antibodies. If polyclonal antibodies are desired, purified protein is used to immunize a selected mammal (e.g., mouse, rabbit, goat, horse, etc.) and serum from the immunized animal later collected and treated according to known procedures. Compositions containing polyclonal antibodies to a variety of antigens in addition to the protein can be made substantially free of anti-  
10           bodies which do not bind specifically to the protein bodies by passing the composition through a column to which protein has been bound. After washing, polyclonal antibodies to the protein are eluted from the column. Monoclonal anti-protein antibodies can also be readily  
15           produced by one skilled in the art. The general methodology for making monoclonal antibodies by hybridomas is well known. Immortal, antibody-producing cell lines can also be created by techniques other than fusion, such as direct transformation of B lymphocytes with oncogenic DNA, or  
20           transfection with Epstein-Barr virus. See, e.g., Schreier, M., et al., HYBRIDOMA TECHNIQUES (1980); Hammerling et al., MONOCLONAL ANTIBODIES AND T-CELL HYBRIDOMAS (1981); Kennett et al., MONOCLONAL ANTIBODIES (1980).

30           By employing the bone-specific protein (native, deglycosylated or synthetic) as an antigen in the immunization of the source of the B-cells immortalized for the production of monoclonal antibodies, a panel of monoclonal antibodies recognizing epitopes at different  
35           sites on the protein molecule can be obtained. Antibodies which recognize an epitope in the binding region of the

-19-

protein can be readily identified in competition assays between antibodies and protein. Antibodies which recognize a site on the protein are useful, for example, in the purification of the protein from cell lysates or fermentation media, in characterization of the protein and in identifying immunologically related proteins. Such immunologically related proteins (i.e., that exhibit common epitopes with the protein) are another aspect of the invention. In general, as is known in the art, the anti-protein antibody is fixed (immobilized) to a solid support, such as a column or latex beads, contacted with a solution containing the protein, and separated from the solution. The protein, bound to the immobilized antibodies, is then eluted. Antibodies to the protein may be used to identify osteoblasts and osteocytes by conventional immunoassay procedures. Such identification may be used to follow bone and/or cartilage turnover.

## 20 Examples

The following is intended to further illustrate processes for preparing the proteins of the invention and their use in preparing antibodies. These examples are not intended to limit the invention in any manner.

25

### A. Preparation of Demineralized Bone

Bovine metatarsal bone was obtained fresh from the slaughterhouse and transported on ice. Bones were cleaned of all periosteum and marrow with high pressure water, crushed into fragments using a liquid-nitrogen-cooled grinder and pulverized into powder using a liquid-nitrogen-cooled mill. The pulverized bone was washed four times for 20 minutes in 4°C deionized water (8 liters/kg). The bone was then washed overnight with the same volume of deionized water at 4°C. The bone powder was demineralized for 5 hr in 0.5 N HCl (21 liter/kg) at 4°C. The acid was

-20-

decanted, and the demineralized bone powder was washed several times with 4°C deionized water until the wash reached a pH>3. The excess water was removed on a suction filter.

5

B. Extraction of Noncollagenous Proteins

Demineralized bone powder was extracted with 4M guanidine-HCl, 10 mM EDTA pH 6.8 (2 liters/kg bone powder) for 16 hr at 4°C. The suspension was suction-filtered to  
10 recover the guanidine-HCl-soluble fraction and concentrated at least 5-fold by ultrafiltration using a 10,000 dalton cut-off membrane (S10Y10 Amicon spiral cartridge).

15 C. Gel Filtration

The extract from 11B, redissolved in 4M guanidine-HCl, was fractionated on a Sephacryl S-200 column equilibrated in 4M guanidine-HCl, 0.02% sodium azide, 10 mM EDTA, pH 6.8. Fractions were assayed by  
20 their absorbance at 280 nm and the fractions were combined as shown in Figure 2. The fraction indicated by <----> in Figure 2 constitutes a low molecular weight (LMW, 10,000-30,000 daltons) protein fraction possessing the greatest activity. This fraction was pooled and dialyzed against 6  
25 changes of 180 volumes of deionized water and lyophilized. All operations except lyophilization and dialysis (4°C) were conducted at room temperature.

D. Ion Exchange Chromatography

30 The pooled fraction from 11C was dissolved in 6M urea, 10 mM NaCl, 1 mM NEM, 50 mM sodium acetate, pH 4.8 and centrifuged at 10,000 rpm for 5 min. The supernatant was fractionated on a CM52 (a commercially available CMC) column equilibrated in the same buffer. Bound proteins  
35 were eluted from the column using a 10 mM to 400 mM NaCl gradient in the same buffer, and a total volume of 350 ml

-21-

at a flow rate of 27 ml/hr. Proteins eluted with 10-150 mM NaCl (the <----> of Figure 3) were collected and dialyzed against 6 changes of 110 volumes of deionized water for 4 days and lyophilized. All of the foregoing operations were conducted at room temperature except dialysis (4°C).

#### E. ConA Chromatography

The fraction obtained in step D above was enriched by affinity chromatography using concanavalin A (ConA)-Sepharose 4B (Pharmacia). In order to minimize leaching of ConA from the column during chromatography, the resin was cross-linked with glutaraldehyde essentially as described by K.P. Campbell, D.H. MacLennan, J Biol Chem (1981) 256:4626. Briefly, resin was pelleted (500 x g, 5 min) and washed twice with 4 volumes of 250 mM NaHCO<sub>3</sub>, pH 8.8. The resin was then equilibrated in the same buffer for 6-8 hrs at 4°C. After pelleting, the resin was cross-linked by the addition of 4 volumes of 250 mM NaHCO<sub>3</sub>, pH 8.8, 250 mM methyl-alpha-D-mannopyranoside (alpha-MM), 0.03% glutaraldehyde with gentle mixing for 1 hr at room temperature. The reaction was quenched by washing the resin twice in 1M Tris-HCl, pH 7.8. The resin was stored in the same buffer containing 0.01% Thimersol at 4°C until use.

Samples for ConA chromatography were solubilized in 1% deoxycholate at pH 8.0. Any small amount of precipitate was removed by centrifugation 12,000 x g, 5 minutes.

Prior to chromatography, cross-linked resin was first equilibrated with >5 column volumes of 50 mM Tris, pH 8.0 followed by >5 column volumes of 1% sodium deoxycholate. Samples were loaded and nonbound fractions collected by washing with 1% DOC. Elution was monitored by OD<sub>280</sub>. Bound material was eluted with 0.5M alpha-MM in 1% DOC as shown in Figure 4.



-22-

#### F. Chromatography on Heparin-Sepharose

The bound fraction eluted from the ConA column was reequilibrated by chromatography on a GH-25 column (Pharmacia) equilibrated in 6M urea, 0.1M NaCl, 50 mM Tris-HCl pH 7.2 heparin-sepharose buffer. Approximately 80 mg (1 mg/ml) were loaded on a 25 ml large heparin sepharose column (Pharmacia). The column was washed of all unbound material. Then bound proteins were eluted with the same equilibrating buffer but containing 0.5M NaCl as shown in Figure 5. About 5-8 mg of heparin-sepharose bound proteins were recovered.

#### G. Chromatography on C18-RP-HPLC

The pH of the heparin-bound fraction was lowered below 5 by adding TFA. Final purification of the heparin-bound fraction was achieved using reversed phase HPLC. The columns used were a Vydac TP-RP18 4.6 mm x 25 cm and 1.0 x 25 cm. Solvent A was 0.1% aqueous trifluoroacetic acid (TFA) and B 90% acetonitrile in A. Bound proteins were eluted from the column with a 32-62% B solvent gradient at a rate of 1%/min. The protein composition eluted between 47-50% solvent B as shown in Figure 6. 140-200 ug protein were recovered. Amino acid composition and amino acid sequences of the protein were determined using standard procedures and are described above and shown in Figure 7.

#### H. Deglycosylation

Glycopeptidase F cleaves N-linked oligosaccharides at the innermost N-acetylglucosamine residue. High mannose, hybrid and complex oligosaccharides are susceptible to the enzyme. Protein was iodinated by the chloramine-T method. Labeled protein was digested for 12-15 hours with 6.7 units/ml glycopeptidase F (Boehringer Mannheim) in 0.1M Tris-HCl, pH 7.4, 10 mM EDTA, at 37°C.

-23-

Both the glycosylated and deglycosylated forms were analyzed by sodium dodecyl sulfate/15% polyacrylamide slab gels prepared according to standard methods. Figure 8 is a photograph of the autoradiograph.

5

#### I. Isolation of Bovine Protein Gene

The protein is designated "OIF" in the drawings.

The following four 20-mer oligonucleotide probes were synthesized using a Biosearch 8600 DNA synthesizer.

10 The sequences of these probes were derived from the amino acid sequence of the bovine protein that was isolated from bone.

15 GCNAARTAYAAYAARATQAA  
TTYCGNTRRTGNAARTTYTT  
CTRCTRGTGNAARACRTTYCG  
CTYCCNTRGGNCANTAWGA

20 where A is adenine, C is cytosine, G is guanine, T is thymine, N is A, C, G or T, Q is A, C, or T, R is A or G, W is A, G or T and Y is C or T.

25 These probes were used to analyze a lambda bacteriophage "library" containing DNA fragments from bovine liver. The lambda phage vector, EMBL3 (Frischauf, A.M., et al., J Mol Biol (1983) 170:827) was purchased (Stratagene, 1190 North Torrey Pines Road, La Jolla, CA 92037) and used as described. Bovine liver was collected at a slaughterhouse and quickly frozen in liquid nitrogen. The frozen tissue was pulverized and lysed with sarkosyl  
30 NL-97A and proteinase K. Cellular DNA was purified by CsCl density gradient centrifugation, treated with Sau3A, and fractionated by sucrose gradient centrifugation after phenol-chloroform extraction.

35 The DNA was concentrated to 1 mg/ml and 1 ug was mixed with 1 ug EMBL3 DNA. The mixture was treated with DNA ligase as described by the supplier and packaged via

-24-

the "gigapack kit" (Stratagene) to make a library stock. Approximately 10,000 viable phage were plated on each of 60 plates (150 mm) (see Molecular Cloning: A Laboratory Manual, Maniatis, Fritsch and Sambrook, Cold Spring Harbor Laboratory, Cold Spring Harbor, New York (1983)).

Phage plaques were transferred to nitrocellulose filters (4 replicates per plate). Absorbed DNA was denatured by treatment with 0.5M NaOH, 1.5M NaCl. Filters were neutralized in 0.5M Tris, pH 8.0, 1.5M NaCl, washed with 2XSSC, air dried, and baked for 2 hr at 80°C under vacuum.

Phage containing the gene were identified by hybridizing <sup>32</sup>P-labeled oligonucleotides with filters containing DNA transferred from phage plaques. Plaques hybridizing in duplicate to at least two of the four oligonucleotides were purified and further characterized. From three experiments representing a total of 6 x 10<sup>5</sup> plaques (2-4 bovine genome equivalents) only two plaques were shown on final analysis to contain sequences compatible with the protein sequence. These two phage (bOIF21 and bOIF39) were shown by restriction site mapping and Southern analysis to contain identical sequences in the bOIF region although the extent of bovine DNA in the two was different.

Sequencing of these clones revealed the gene structure shown in Figure 9 and the DNA sequence of Figure 11. As shown, the mature bovine sequence is encoded by three exons, designated 1, 2, and 3 in Figure 9. Exon 1 encodes the first 17 amino acids, Exon 2 amino acids 18 through 49, and Exon 3 the remaining residues. The precursor segment of the prepropolypeptide is encoded by a portion of Exon 1 and separate exons upstream from Exon 1.

To confirm the splicing of the exons, a bovine cancellous bone mRNA library was prepared using the polymerase chain reaction (PCR) with primers selected from within Exons 1 and 3. A clone containing the bOIF cDNA

-25-

sequence was isolated and the nucleotide sequence determined. The resulting sequence confirmed the exon splicing contemplated by Figures 9 and 11.

5 J. Isolation of Human Protein Gene

Human fetal liver DNA was isolated, treated with Sau3A as was described for bovine DNA (above). Phage plaques ( $2.5 \times 10^5$ ) form the EMBL3 human liver DNA library (generated as described above) and a similar number of  
10 plaques from a human liver DNA library produced in lambda phage Charon 4a (Lawn, R.M., et al., Cell (1978) 15:1157) were probed with a radioactively-labeled (EcoRI) DNA fragment (Fragment 1, Figure 9) containing the first exon of the bovine gene. All positive appearing plaques (13 from  
15 the EMBL3 library and 6 from the Charon 4a) were isolated and reprobbed with the radioactive exon 1 DNA fragment as well as a second DNA fragment containing exon 3 (Fragment 2, Figure 9) of the bovine gene. Only one phage from the EMBL3 library (phage 41) hybridized to both DNA fragments  
20 and a second phage (phage 28) from the gene library hybridized with only the exon 1 fragment upon rescreening. All other phage did not hybridize with the radioactive probes upon rescreening, indicating that their original identification was either an artifact of hybridization or  
25 that the human protein cognate DNA was lost upon replication during isolation of the phage.

Phage 41 and 28 were subjected to restriction site mapping and Southern blot analysis to locate the sequences for the human probes and the DNA sequence of  
30 these regions was determined.

Sequencing of these clones showed that the human gene structure paralleled that shown in Figure 9, that is the human gene for the mature protein comprises three exons of identical length to the bovine exons. A restriction map of the human gene region is shown in Figure 10.  
35 It was further determined that the human protein, as the

-26-

bovine, occurs as a prepropolypeptide with the precursor segment being encoded by a portion of Exon 1 and upstream exons. The human genomic DNA sequence is shown in Figure 11.

5

K. Construction of Mammalian Expression Vector Containing Human Protein Gene

A HindIII fragment of the human protein gene (site 15422 to site 25814 in Figure 10) was cloned into a HindIII site of plasmid pSC614 (see Figure 12) in transcriptional alignment with the SV40 promoter or in the opposite orientation to yield plasmids phOIF17 and phOIF18 respectively. Figure 12 is a schematic diagram of plasmid phOIF18.

15

L. Transfection of COS-7 Cells with phOIF18

COS-7 cells were transfected with phOIF18 (see Felgner, P.L., et al., Proc Natl Acad Sci (USA) (1987) 84:7413). After transfection the cells were allowed to grow in medium with or without serum (5%). In these experiments only the cells grown in serum-containing media synthesized the protein.

20

M. Production and Testing of Antibodies to the Protein

25

M.1. Production of Polyclonal Antibodies

Polyclonal antibodies to (1) a synthetic 30-mer polypeptide having a sequence corresponding to the amino acids 1-30 of Figure 7 except for a Leu ----> Asn substitution at position 25 and (2) the native protein purified from bone as described above were prepared and characterized as follows.

30

Antiserum to the 1-30-mer was raised in a rabbit by injecting the rabbit with 500 ug of the polypeptide in complete Freund's adjuvant (CFA), followed by boosts of 500 ug of the polypeptide in incomplete Freund's adjuvant (ICFA) at approximately three week intervals. The

35

-27-

antiserum was obtained after the fourth boost and had a titer as measured by ELISA of >1:10,000. Rabbit antiserum to the native protein was raised similarly using an initial injection of 50 ug protein in CFA followed by 5 boosts of 50 ug protein in ICFA. This antiserum had a titer of >1:10,000 by ELISA.

The antiserum to the 1-30-mer was tested in Western blots on the purified native protein, deglycosylated native protein, and on crude native protein (Con-A bound material), all fixed post-blotting with 0.2% glutaraldehyde. The antiserum detected the purified native protein at  $\geq 1$  ug and also recognized the deglycosylated protein and the crude protein. The antiserum to the native protein recognized the native protein at  $\geq 100$  ng in Western blots.

#### M.2. Production of Monoclonal Antibodies

Murine monoclonal antibodies to the purified native protein were prepared as follows. From two fusions 20 25 positive wells were identified by immunoprecipitation. A group of female Balb/c mice was injected intraperitoneally (IP) with 10-20 ug of purified native protein in CFA. The animals were boosted with 10-20 ug of protein in ICFA. Following the third boost, the mice were 25 bled and serum antibody titers against the protein checked by ELISA. Two animals were found to have titers of  $\geq 1:40,000$ . They were given a final intravenous (IV) injection of 20 ug protein four days prior to the fusion.

Fusion to the SP2/0 myeloma (GM3659 B, NIGMS 30 Human Genetic Mutant Cell Repository, Camden, NJ) was performed essentially according to the protocol of Oi and Herzenberg, "Immunoglobulin-producing Hybrid Cell Lines" in Selected Methods in Cellular Immunology, Mishell and Shiigi, eds., W.H. Freeman and Co., San Francisco, pp. 35 357-362, (1980). Spleen cells from the animals were mixed with SP2/0 at a ratio of 5:1. 50% polyethylene glycol

-28-

1500 (Boehringer-Mannheim Biochemicals, Indianapolis, IN) was used as the fusagen. Cells were plated at  $10^6$  cells/well along with resident peritoneal cells at  $4 \times 10^3$  cells/well in DMEM with high glucose (4.5 g/l) supplemented with 20% FCS (Hyclone Laboratories, Logan, UT), 2 mM L-glutamine, 2 mM sodium pyruvate, nonessential amino acids, penicillin and streptomycin. In this procedure, aminopterin was replaced by azaserine (Sigma) according to the procedure by Larrick et al., Proc Natl Acad Sci (USA) (1983) 80:6376, and added along with thymidine and hypoxanthine on day 1 after the fusion.

From two fusions 25 positive wells were identified by immunoprecipitation of  $^{125}$ I-labeled protein.

All 25 were also positive in an ELISA against the protein. In addition, several other wells were positive by ELISA but negative by immunoprecipitation. The supernatant from one uncloned well (3B2.17, previously designated FO13-3B2) was particularly positive and was used in a Western blot. In this testing synthetic peptides corresponding to amino acid segments 1-30, 62-95 and 76-105 of the protein sequence were made and 1-2 ug of each was applied to separate lanes in the gel. Blots were probed with 50-100 ug/ml of purified antibody. This antibody recognized  $\geq 300$  ng protein as well as deglycosylated protein. The antibody also picked up the protein in a crude fraction (total Con-A bound) and was found to recognize the C-terminal peptide (76-105) but not the N-terminal peptide (1-30). Another clone, designated 2C11.6, was found to recognize the internal 62-95 segment. Clones 3B2.17 and 2C11.6 were subcloned by limiting dilution and were found to be stable and to be IgG isotype. These clones have been deposited in the American Type Culture Collection (ATCC) on 5 April 1989 under the provisions of the Budapest Treaty. Their ATCC designations are, respectively, HB10099 (3B2.17) and HB10098 (2C11.6).

-29-

### M.3. Immunostaining With Antibodies

Rat fetuses (19 days old) and 3 day old rats were used for tissue sections. Tissue was fixed in 10% formalin and 5u sections were prepared in paraffin. The  
5 sections were treated with xylene (deparaffinized) and washed with Tris-buffered saline (TBS), pH 7.6, three times. The washed sections were then contacted with a mixture of TBS, 0.05% Tween, 0.5% bovine serum albumin (BSA), 10% normal mouse serum (NMS), for 1 hr at 25°C or  
10 overnight at 4°C. Monoclonal antibody 3B2 (see M.2) at 5 ug/ml in TBS/Tween/BSA/NMS was added and the sections were incubated for 1 hr at room temperature. The sections were then washed three times in TBS/Tween and contacted with  
15 biotinylated goat anti-mouse antibody for 10 min at room temperature. The sections were then washed again three times with TBS/Tween and contacted with streptavidin-horseradish peroxidase for 10 min at room temperature. Thereafter, the sections were washed a final three times  
20 with TBS/Tween and contacted with substrate. After substrat. treatment, the sections were washed in water, counterstained with Mayer's hematoxylin, washed again in water, dehydrated in 100% ethanol, and mounted.

The most intenst staining occurred in hypertrophic calcifying cartilage in the growth plate.  
25 There was also a clear staining pattern in osteoblasts and osteocytes with the darkest in more mature cells. No detectable staining was observed in soft tissue. A faint pattern was seen in bone itself.

30 Modifications of the above-described modes of carrying out the invention that are obvious to those of skill in the arts relevant to the invention are intended to be within the scope of the following claims.



-30-

Claims

1. A substantially pure polypeptide having the following amino acid sequence:

5  
 (H<sub>2</sub>N)-Ala-Lys-Tyr-Asn-Lys-Ile-Lys-Ser-Arg-Gly-  
 Ile-Lys-Ala-Asn-R<sup>1</sup>-Phe-Lys-Lys-Leu-R<sup>2</sup>-  
 Asn-Leu-R<sup>3</sup>-Phe-Leu-Tyr-Leu-Asp-His-Asn-  
 Ala-Leu-Glu-Ser-Val-Pro-Leu-Asn-Leu-Pro-  
 10 Glu-Ser-Leu-Arg-Val-Ile-His-Leu-Gln-Phe-  
 Asn-Asn-Ile-R<sup>4</sup>-Ser-Ile-Thr-Asp-Asp-Thr-  
 Phe-Cys-Lys-Ala-Asn-Asp-Thr-Ser-Tyr-Ile-  
 Arg-Asp-Arg-Ile-Glu-Glu-Ile-Arg-Leu-Glu-  
 Gly-Asn-Pro-R<sup>5</sup>-R<sup>6</sup>-Leu-Gly-Lys-His-Pro-  
 15 Asn-Ser-Phe-Ile-Cys-Leu-Lys-Arg-Leu-Pro-  
 Ile-Gly-Ser-Tyr-R<sup>7</sup>-(COOH),

where R<sup>1</sup> is Ala or Thr, R<sup>2</sup> is Asn or His, R<sup>3</sup> is Thr or  
 Ser, R<sup>4</sup> is Ala or Thr, R<sup>5</sup> is Ile or Val, R<sup>6</sup> is Val or Ile  
 20 and R<sup>7</sup> is Phe or Ile, and substantially pure polypeptides  
 that are and substantially homologous thereto or are  
 immunologically related thereto.

2. The polypeptide of claim 1 wherein R<sup>1</sup> is  
 25 Ala, R<sup>2</sup> is Asn, R<sup>3</sup> is Thr, R<sup>4</sup> is Ala, R<sup>5</sup> is Ile, R<sup>6</sup> is  
 Val, and R<sup>7</sup> is Phe.

3. The polypeptide of claim 1 wherein R<sup>1</sup> is  
 Thr, R<sup>2</sup> is His, R<sup>3</sup> is Ser, R<sup>4</sup> is Thr, R<sup>5</sup> is Val, R<sup>6</sup> is  
 30 Ile, and R<sup>7</sup> is Ile.

4. A substantially pure prepolypeptide  
 comprising

- 35 (a) the polypeptide of claim 1 and  
 (b) at least a portion of a precursor segment  
 having the sequence shown in Figure 11A or Figure 11B,  
 or a sequence substantially homologous thereto.

-31-

5. A substantially pure prepropolypeptide comprising

- (a) the polypeptide of claim 2 and  
 5 (b) at least a portion of a precursor segment having the human sequence shown in Figure 11, Parts A and B,  
 or a sequence substantially homologous thereto.

10 6. A substantially pure prepropolypeptide comprising

- (a) the polypeptide of claim 3 and  
 (b) at least a portion of a precursor segment having the bovine sequence shown in Figure 11, Part B,  
 15 or a sequence substantially homologous thereto.

7. A polypeptide having the following amino acid sequence:

20 (H<sub>2</sub>N)-Ala-Lys-Tyr-Asn-Lys-Ile-Lys-Ser-Arg-Gly-  
 Ile-Lys-Ala-Asn-R<sup>1</sup>-Phe-Lys-Lys-Leu-R<sup>2</sup>-  
 Asn-Leu-R<sup>3</sup>-Phe-Leu-Tyr-Leu-Asp-His-Asn-  
 Ala-Leu-Glu-Ser-Val-Pro-Leu-Asn-Leu-Pro-  
 Glu-Ser-Leu-Arg-Val-Ile-His-Leu-Gln-Phe-  
 25 Asn-Asn-Ile-R<sup>4</sup>-Ser-Ile-Thr-Asp-Asp-Thr-  
 Phe-Cys-Lys-Ala-Asn-Asp-Thr-Ser-Tyr-Ile-  
 Arg-Asp-Arg-Ile-Glu-Glu-Ile-Arg-Leu-Glu-  
 Gly-Asn-Pro-R<sup>5</sup>-R<sup>6</sup>-Leu-Gly-Lys-His-Pro-  
 Asn-Ser-Phe-Ile-Cys-Leu-Lys-Arg-Leu-Pro-  
 30 Ile-Gly-Ser-Tyr-R<sup>7</sup>-(COOH),

where R<sup>1</sup> is Ala or Thr, R<sup>2</sup> is Asn or His, R<sup>3</sup> is Thr or Ser, R<sup>4</sup> is Ala or Thr, R<sup>5</sup> is Ile or Val, R<sup>6</sup> is Val or Ile and R<sup>7</sup> is Phe or Ile, wherein said polypeptide is  
 35 deglycosylated relative to a native polypeptide having said sequence and deglycosylated polypeptides that are substantially homologous thereto or are immunologically related thereto.

-32-

8. Antibody that binds to a polypeptide of claim 1, 2, 3, or 7.

5           9. A recombinant polynucleotide encoding a polypeptide of claim 1, 2 or 3.

10           10. A recombinant polynucleotide encoding a prepolypeptide of claim 4, 5, or 6.

15           11. A recombinant vector containing a recombinant polynucleotide of claim 9 and capable of directing the expression of the polypeptide encoded thereby.

20           12. A recombinant vector containing a recombinant polynucleotide of claim 10 and capable of directing the expression of the prepolypeptide encoded thereby.

25           13. A recombinant host cell or microorganism containing the recombinant vector of claim 11 and capable of permitting expression of said polypeptide.

30           14. A recombinant host cell or microorganism containing the recombinant vector of claim 12 and capable of permitting expression of said polypeptide.

35

35

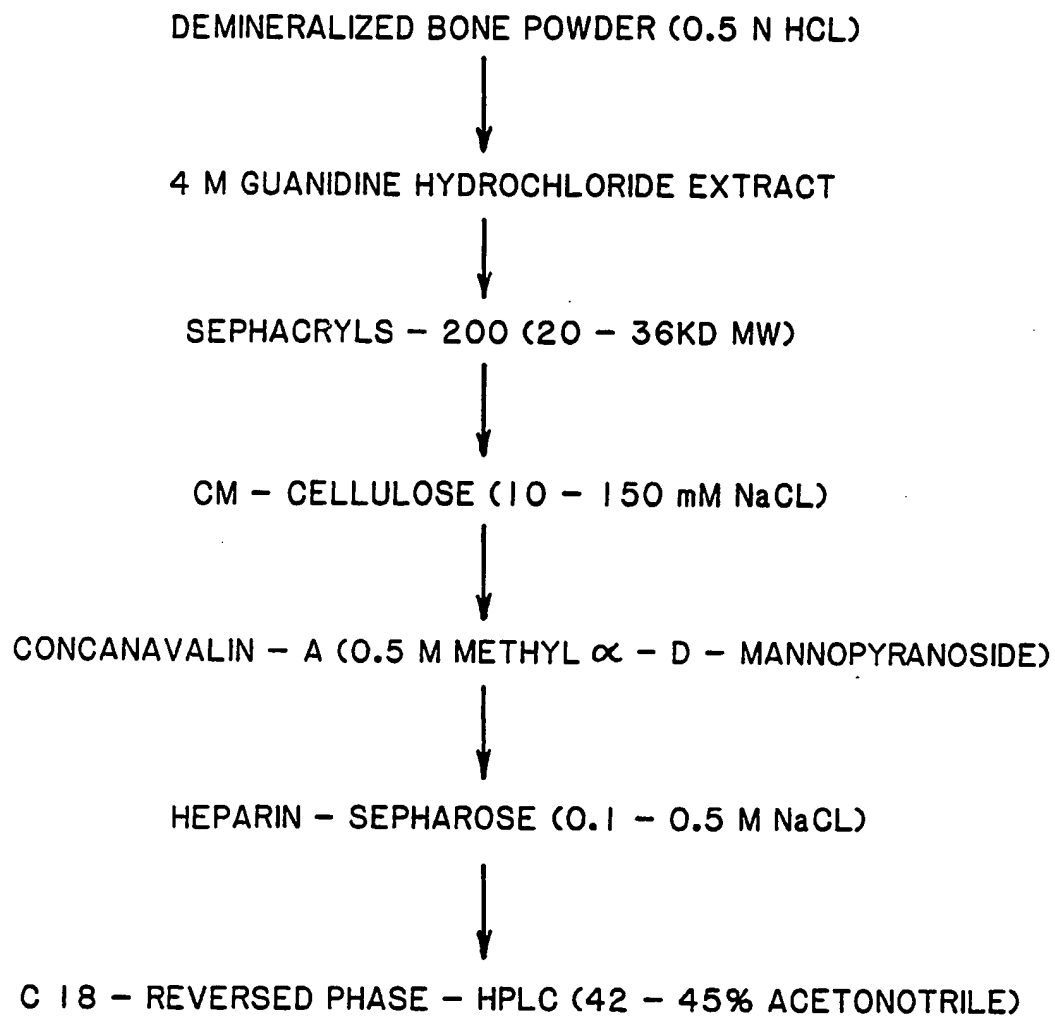

FIG. 1

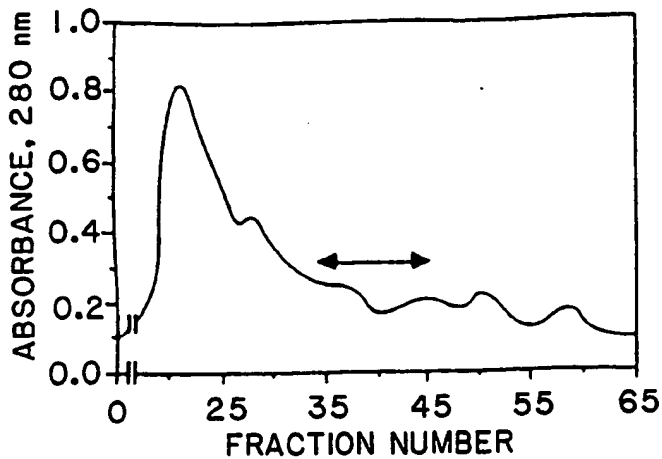

FIG. 2

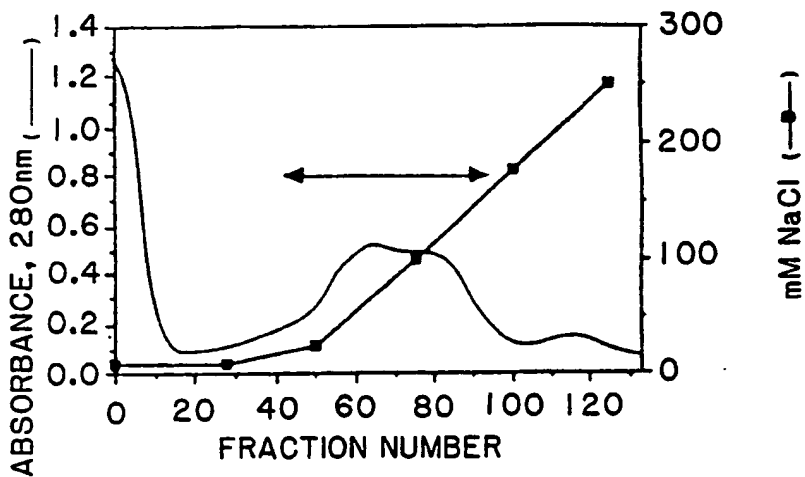

FIG. 3

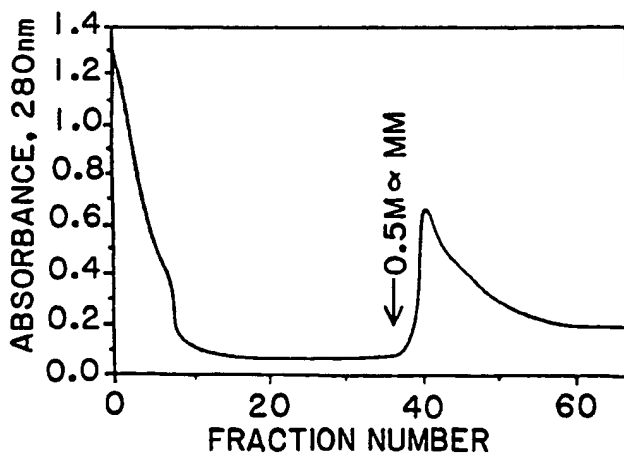

FIG. 4

FIG. 7-1

AA #	N-	LYS-C	GLU-C	LYS-C	GLU-C	LYS-C
1	ALA					
2	LYS					
3	TYR					
4	ASN					
5	LYS					
6	ILE					
7	LYS					
8	SER					
9	ARG					
10	GLY					
11	ILE					
12	LYS					
13	ALA					
14	ASN					
15	THR					
16	PHE					
17	LYS					
18	LYS	(LYS)				
19	LEU	LEU				
20	HIS	HIS				
21	ASN	ASN				
22	LEU	LEU				
23	SER	SER				
24	PHE	PHE				
25	LEU	LEU				
26	TYR	TYR				
27	LEU	LEU				
28	ASP	ASP				
29	HIS	HIS				
30	ASN	ASN				
31	ALA	ALA				
32	LEU	LEU				
33	GLU	GLU				
34		SER				
35		VAL				
36		PRO				
37		LEU				
38		ASN				
39		LEU				
40		PRO				
41		GLU				
42		SER	SER			
43		LEU	LEU			
44			ARG			
45			VAL			
46			ILE			
47			HIS			
48			LEU			
49			GLN			
50			PHE			
51			ASN			
52			ASN			

FIG. 7-2

53			ILE			
54			THR			
55			SER			
56			ILE			
57			THR			
58			ASP			
59			ASP			
60			THR			
61			PHE			
62			CYS			
63			LYS			
64			ALA	ALA		
65				ASN-CHO		
66				ASP		
67				THR		
68				SER		
69				TYR		
70				ILE		
71				ARG		
72				ASP		
73				ARG		
74				ILE		
75				GLU		
76				GLU		
77				ILE		
78				ARG		
79				LEU		
80				GLU		
81				GLY	GLY	
82				ASN	ASN	
83				PRO	PRO	
84				VAL	VAL	
85				ILE	ILE	
86				LEU	LEU	
87				GLY	GLY	
88				LYS	LYS	
89					HIS	
90					PRO	
91					ASN	
92					SER	
93					PHE	
94					ILE	
95					CYS	
96					LEU	
97					LYS	
98					ARG	ARG
99					LEU	LEU
100					PRO	PRO
101					ILE	ILE
102					GLY	GLY
103					SER	SER
104					TYR	TYR
105						ILE-COOH

# FIG. 8

ENZ	-	+	-	+
	115B		115D	
	└───┘		└───┘	

45K -

30K -

20K -

14K -

\*\*\*





Bovine OIF  
Gene Region  
13.7 Kbp

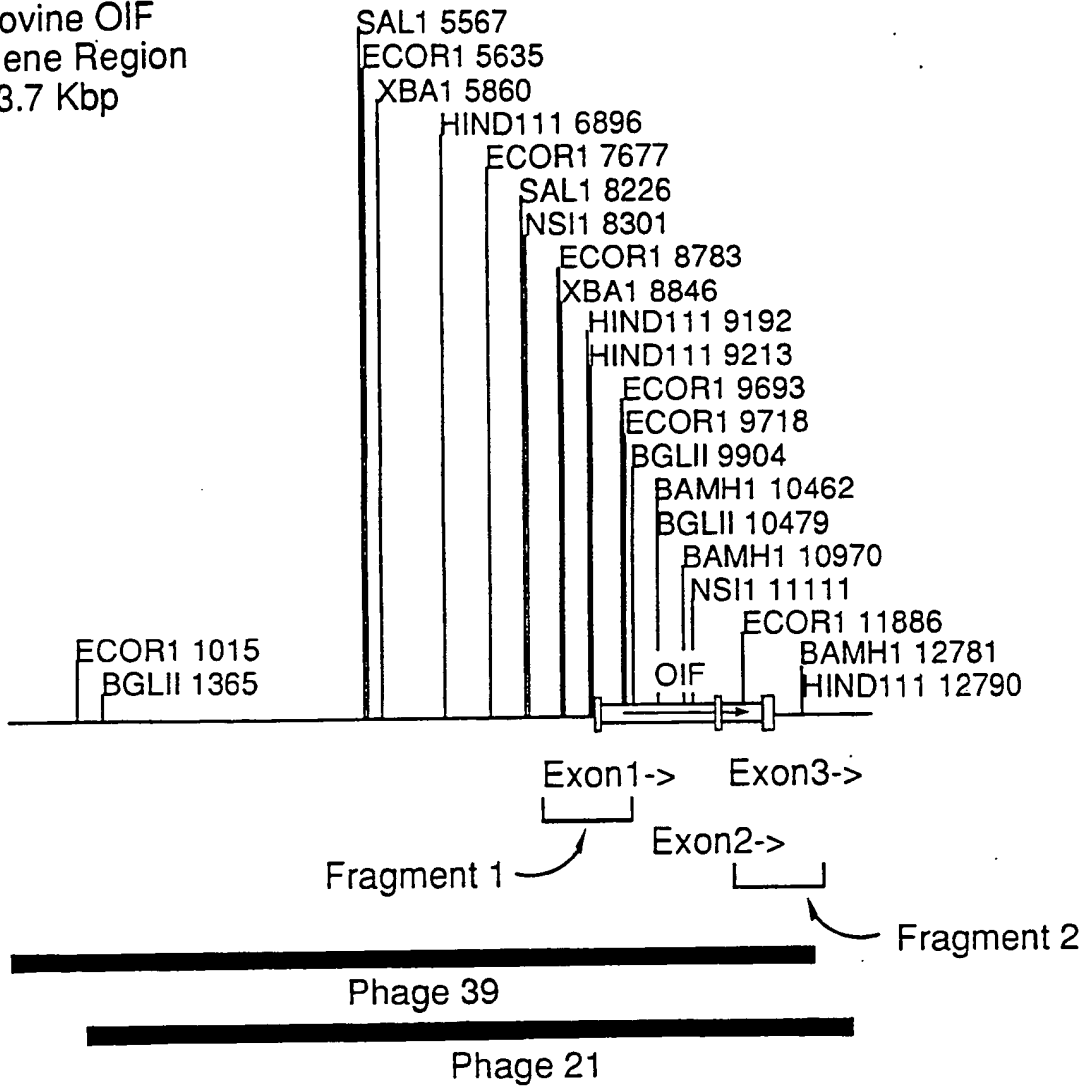
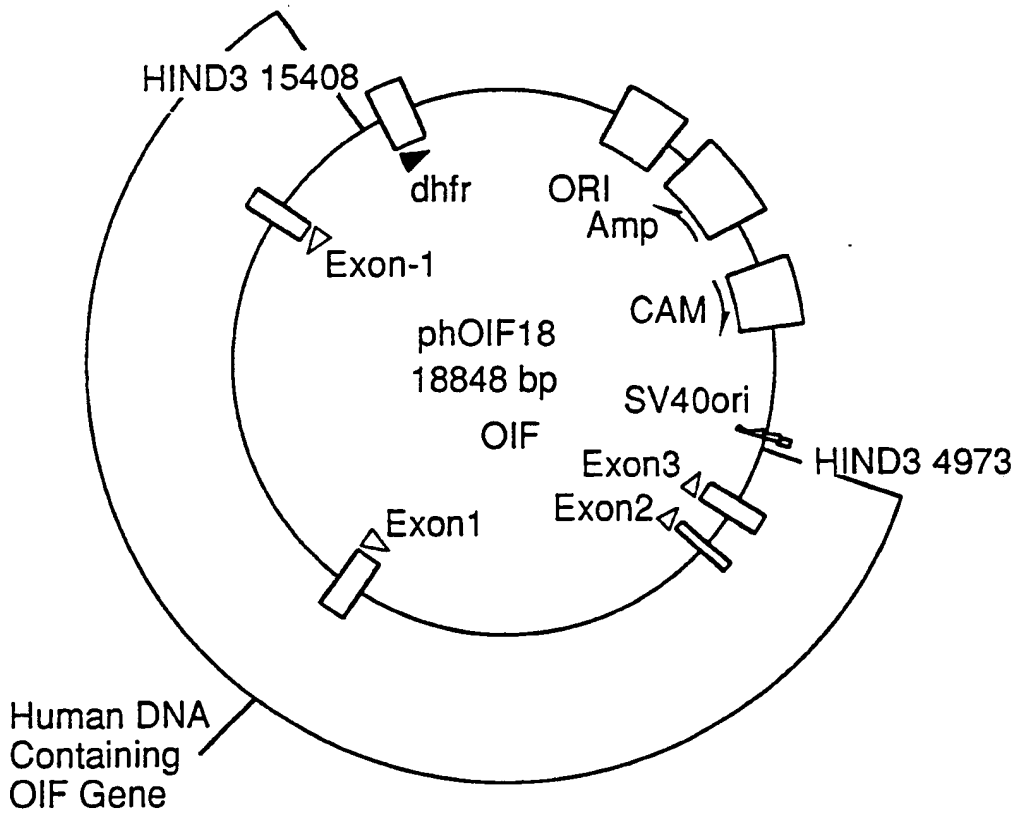
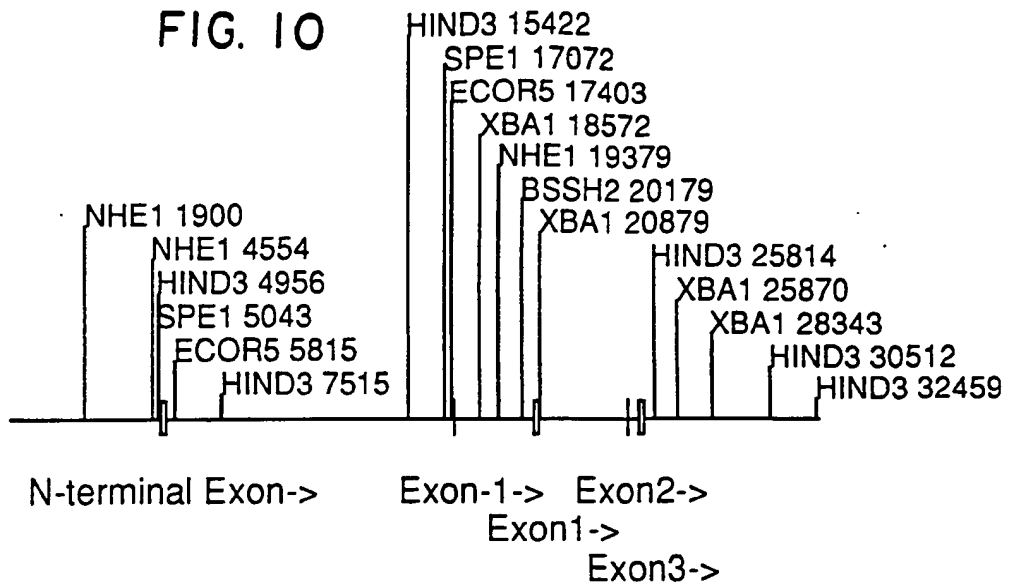

FIG. 9



**FIG. 12**

9 / 17  
 AMINO TERMINAL EXON OF preproOIF

1 A AGC TTT AAA TAT TGC TTC GAT GGT CTG AAT TTT TAT  
 T TCG AAA TTT ATA ACG AAG CTA CCA GAC TTA AAA ATA  
  
 TTC CAG GGA AAA AGA GAG TTT TGT CCC ACA GTC AGC  
 AAG GTC CCT TTT TCT CTC AAA ACA GGG TGT CAG TCG  
  
 AGG CCA CTA GTT TAT TAA CTT CCA GTC ACC TTG ATT  
 TCC GGT GAT CAA ATA ATT GAA GGT CAG TGG AAC TAA

▲  
 SPE1

Signal Sequence

\*\*\* \*\*\* \*\*\* \*\*\* \*\*\* \*\*\* \*\*\* \*\*\* \*\*\*  
 Met Lys Thr Leu Gln Ser Thr Leu Leu  
 TTT GCT AAA ATG AAG ACT CTG CAG TCT ACA CTT CTC  
 AAA CGA TTT TAG TTC TGA GAC GTC AGA TGT GAA GAG

▲  
 PST1

\*\*\* \*\*\* \*\*\* \*\*\* \*\*\* \*\*\* \*\*\* \*\*\* \*\*\*  
 Leu Leu Leu Leu Val Pro Leu Ile Lys Pro Ala Pro  
 CTG TTA CTG CTT GTG CCT CTG ATA AAG CCA GCA CCA  
 GAC AAT GAC GAA CAC GGA GAC TAT TTC GGT CGT GGT

Pro Thr Gln Gln Asp Ser Arg Ile Ile Tyr Asp Tyr  
 CCA ACC CAG CAG GAC TCA CG7 ATT ATC TAT GAT TAT  
 GGT TGG GTC GTC CTG AGT GC0 TAA TAG ATA CTA ATA

Gly Thr Asp Asn Phe Glu Glu Ser Ile Phe Ser Gln  
 GGA ACA GAT AAT TTT GAA GAA TCC ATA TTT AGC CAA  
 CCT TGT CTA TTA AAA CTT CTT AGG TAT AAA TCG GTT

Asp Tyr Glu Asp Lys Tyr Leu Asp Gly Lys Ile Leu  
 GAT TAT GAG GAT AAA TAC CTG GAT GGA AAA ATA TTA  
 CTA ATA CTC CTA TTT ATG GAC CTA CCT TTT TAT AAT

Arg Tyr Phe Ile Phe Tyr Ser Lys Phe Ser Phe Leu  
 AGG TAC TTT ATT T8C TAT TCT AAA TTT AGC TT8 CTA  
 TCC ATG AAA TAA A9G ATA AGA TTT AAA TCG AA9 GAT

Asn Thr Ala  
 AAT ACT GCC C  
 TTA TGA CGG G

FIG.11-1

PART A

SUBSTITUTE SHEET

-60

JAGGTRAGT

Lys Ile Lys Lys Leu Thr Ala Lys Asp Phe Ala Asp Ile P↓  
 AAAATTAAAAGCTGACTGCCCAAAGATTTGCAGACATACGTTAAGCTGAAAATATGATATTAGTATTA  
 \*\*\*\*\*  
 AAAATTAAAAGCTGACCGCCCAAAGATTTGCAGACATACGTTAAGCTAATTTTAAAATAAAAATATTAGTGTTA  
 Lys Ile Lys Lys Leu Thr Ala Lys Asp Phe Ala Asp Ile P

-60

FIG. 11-3  
PART B



10 JAGGTRAGT  
 Lys Tyr Asn Lys Ile Lys Ser Arg Gly Ile Lys Ala Asn Ala Phe Lys  
 AAATACAACA AATCAAGAGTAGGGAAATCA AAGCAAATGCATTC A AAGTATTTATAGTAAACTAA  
 \*\*\*\*\*  
 AAATATAACA A AATCAAGAGTAGAGGAAATCA AAGCAAATACATTC A AAGTATTTATAGTATGACTGA  
 Lys Tyr Asn Lys Ile Lys Ser Arg Gly Ile Lys Ala Asn Thr Phe Lys

GCATAGTATGAGTGATGATATGATAGATAAAAGAGAAACTTTGGTCTAGA  
 \*\*\* \* \*\*\* \*\* \*\* \* \* \* \* \*  
 GCACAATATAATATCATTTGTTATACAGCCCAATAATAACATGATAAAAG

FIG.11-5  
PART C

JAGGTRAGT  
 Gin  
 CAGGTATGATAGTTCCTT9CACAAATATCTGACTCTAATTACCTATGAGTCAAAAATCTTGTGA  
 \*\*\*\*\* \* \*\*\*\*\* \* \*\*\*\*\* \* \*\*\*\*\* \* \* \* \*  
 CAGGTATGATTTGCTCCTTTCACAGTATCAGACTTTAATTCAAAATTACTATGCGGTCAATCTTA  
 Gin  
 JAGGTRAGT

FIG.11-7  
PART D

EXON 3

	50			60
	YYYYYYYYYYNYAG			
HUMAN			PheAsnAsnIleAlaSerIleThrAspAspThrPheCys	
	TTTCTGAACAATGTTTCCCTCGTTTTCAGTTCAACAACATAGCTTCAATTACAGATGACACATTCTGC			
*	* * * * *		*****	
*	* * * * *		*****	
GGAGTTATAAAGTATTTCCTTCCAGTTTAAACAACATAACTTCAATTACAGATGATACATTCTGC				
BOVINE			PheAsnAsnIleThrSerIleThrAspAspThrPheCys	
	YYYYYYYYYYNYAG			
			CHO	

		70		80
	LYSAlaAsnAspThrSerTyriIleArgAspArgIleGluGluIleArgLeuGluClyAsnProIleValLeu			
	AAGGCTAATGACACCCAGTTACATCCGGACCAGCATTTGAAAGAGATACGCCCTGGAGGGCAATCCAATCGTCCTG			
*	*****		*****	
*	*****		*****	
AAGGCTAATGACACCCAGTTATATTCGGACCAGCATTTGAAAGAGATACGCCCTGGAGGGCAACCCCGTCATCCTG				
LysAlaAsnAspThrSerTyriIleArgAspArgIleGluGluIleArgLeuGluGlyAsnProValIleLeu				
			CHO	

FIG. 11-8  
PART E



90  
 GlyHisProAsnSerPheIleCysLeuLysArgLeuProIleGlySerTyrPhe  
 GAAAGCATCCAAACAGTTTATTTGCTTAAAAGATTACCGATACGGTCATACTTTTAAACCTCTATTGGTA  
 \*\* \*\* \*\*\*\*\* \*\* \*\* \*\*\*\*\* \*\* \*\* \*\*\*\*\* \*\* \*\* \*\*\*\*\* \*\* \*\* \*\*\*\*\* \*\* \*\* \*\*\*\*\* \*  
 GGAACAATCCCAACAGTTTATCTGCTTAAAAGATTGCCATAGGGTCATACATTTAACCCACNATCAATG  
 GlyHisProAsnSerPheIleCysLeuLysArgLeuProIleGlySerTyrIle

CAACATATAAATGAAAGTACACCTACACTAATAGTCTGTCTCAACAATGTGTAAGGAACCTTAAGTATTGGT  
 \*\* \*\* \*\*\*\*\* \*\* \*\* \*\*\*\*\* \*\* \*\* \*\*\*\*\* \*\* \*\* \*\*\*\*\* \*\* \*\* \*\*\*\*\* \*\* \*\* \*\*\*\*\* \*  
 CAG ATA GCTAAAGTACACACATACTTATAATCTGTCTCAACAATGTCTAAACCAGCATAAATATT

Poly A  
 Addition  
 Site  
 TTAATATAACCTTGTATCTCATT  
 \*\*\*\*\* \*\* \*\* \*\*\*\*\* \*\* \*\*  
 TAATATAATTTGCATCTGACT  
 Poly A  
 Addition  
 Site

FIG.11-9  
PART E

# INTERNATIONAL SEARCH REPORT

International Application No. PCT/US90/04745

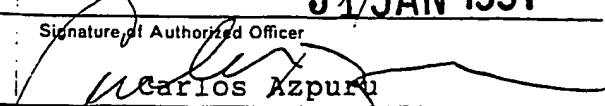
<b>I. CLASSIFICATION OF SUBJECT MATTER</b> (if several classification symbols apply, indicate all) <sup>6</sup>		
According to International Patent Classification (IPC) or to both National Classification and IPC IPC (5): C07K 15/06, 3/02, 3/20, 13/00; A61K 35/12, 37/12; A01N 63/02; A23J 1/10 U.S. CL. 424/95		
<b>II. FIELDS SEARCHED</b>		
Minimum Documentation Searched <sup>7</sup>		
Classification System	Classification Symbols	
U.S.	424/95; 514/2, 12, 21; 530/350, 353, 355, 356 530/ 414, 416, 417, 540	
Documentation Searched other than Minimum Documentation to the Extent that such Documents are Included in the Fields Searched <sup>8</sup>		
<b>III. DOCUMENTS CONSIDERED TO BE RELEVANT</b> <sup>9</sup>		
Category <sup>*</sup>	Citation of Document, <sup>11</sup> with indication, where appropriate, of the relevant passages <sup>12</sup>	Relevant to Claim No. <sup>13</sup>
A	US, A, 4,294,753 (URIST) 13 OCTOBER 1981 See entire document.	1-7
A	US, A, 4,434,094 (SEYEDIN ET AL) 28 FEBRUARY 1984; See entire document.	1-7
A	US, A, 4,455,256 (URIST) 19 JUNE 1984 See entire document.	1-7
A	US, A, 4,608,199 (CAPLAN ET AL) 26 AUGUST 1986; See entire document.	1-7
A	US, A, 4,627,982 (SEYEDIN ET AL) 09 DECEMBER 1986; See entire document.	1-7
A	US, A, 4,774,322 (SEYEDIN ET AL) 27 SEPTEMBER 1988; See entire document.	1-7
A	US, A, 4,789,732 (URIST) 06 DECEMBER 1988 See entire document.	1-7
A	US, A, 4,795,804 (URIST) 03 JANUARY 1989 See entire document.	1-7
<p><sup>*</sup> Special categories of cited documents: <sup>10</sup></p> <p>"A" document defining the general state of the art which is not considered to be of particular relevance</p> <p>"E" earlier document but published on or after the international filing date</p> <p>"L" document which may throw doubts on priority claim(s) or which is cited to establish the publication date of another citation or other special reason (as specified)</p> <p>"O" document referring to an oral disclosure, use, exhibition or other means</p> <p>"P" document published prior to the international filing date but later than the priority date claimed</p> <p>"T" later document published after the international filing date or priority date and not in conflict with the application but cited to understand the principle or theory underlying the invention</p> <p>"X" document of particular relevance; the claimed invention cannot be considered novel or cannot be considered to involve an inventive step</p> <p>"Y" document of particular relevance; the claimed invention cannot be considered to involve an inventive step when the document is combined with one or more other such documents, such combination being obvious to a person skilled in the art.</p> <p>"&amp;" document member of the same patent family</p>		
<b>IV. CERTIFICATION</b>		
Date of the Actual Completion of the International Search		Date of Mailing of this International Search Report
19 DECEMBER 1990		31 JAN 1991
International Searching Authority		Signature of Authorized Officer
TSA/US		 Carlos Azpuru

III. DOCUMENTS CONSIDERED TO BE RELEVANT (CONTINUED FROM THE SECOND SHEET)		
Category *	Citation of Document, with indication, where appropriate, of the relevant passages	Relevant to Claim No
A	US, A, 4,810,691 (SEYEDIN ET AL) 07 MARCH 1989; See entire document.	1-7
A	US, A, 4,816,442 (McPHERSON ET AL) 28 MARCH 1989; See entire document.	1-7
A	WO, A1, WO88/00205 (WANG ET AL) 14 JANUARY 1988; See entire document.	1-7
A	EP, A2, 0212474 (URIST ET AL) 04 MARCH 1987 See entire document.	1-7
A	Reddi et al., <u>Proc. Nat. Acad. Sci. USA</u> (1972) Vol. <u>69</u> : 1601-1605. See entire document.	1-7
A	Urist et al., <u>Scienu</u> (1965) Vol. <u>150</u> : 893-899. See entire document.	1-7
A	Urist et al., <u>Clin. Orthop.</u> (1968) Vol. <u>56</u> : 37-50. See entire document.	1-7
A	Urist et al., <u>Clin. Orthop. Rel. Res.</u> (1982) Vol. <u>162</u> : 219-232. See entire document.	1-7
A	Urist et al., <u>Science</u> (1983) Vol. <u>220</u> : 680-685. See entire document.	1-7
A	Urist et al., <u>Proc. Nat. Acad. Sci. USA</u> (1984) Vol. <u>81</u> : 371-375. See entire document.	1-7
A	EP, A3, 0128041 (BAYLINK) 12 DECEMBER 1984 See entire document.	1-7
A	Jennings et al., <u>Meth. Enzymol.</u> (1987) Vol. <u>146</u> : 281-283. See entire document.	1-7

## FURTHER INFORMATION CONTINUED FROM THE SECOND SHEET

V.  OBSERVATIONS WHERE CERTAIN CLAIMS WERE FOUND UNSEARCHABLE <sup>1</sup>

This international search report has not been established in respect of certain claims under Article 17(2) (a) for the following reasons:

1.  Claim numbers \_\_\_\_\_, because they relate to subject matter <sup>12</sup> not required to be searched by this Authority, namely:

2.  Claim numbers \_\_\_\_\_, because they relate to parts of the international application that do not comply with the prescribed requirements to such an extent that no meaningful international search can be carried out <sup>13</sup>, specifically:

3.  Claim numbers \_\_\_\_\_, because they are dependent claims not drafted in accordance with the second and third sentences of PCT Rule 6.4(a).

VI.  OBSERVATIONS WHERE UNITY OF INVENTION IS LACKING <sup>2</sup>

This International Searching Authority found multiple inventions in this international application as follows:

Group I: Claims 1-7, drawn to a polypeptide.

Group II: Claim 8, drawn to an antibody.

Group III: Claims 9 & 10, drawn to a recombinant polynucleotide.

Group IV: Claims 11-14, drawn to a recombinant vector and host

cell.

1.  As all required additional search fees were timely paid by the applicant, this international search report covers all searchable claims of the international application.

2.  As only some of the required additional search fees were timely paid by the applicant, this international search report covers only those claims of the international application for which fees were paid, specifically claims:

3.  No required additional search fees were timely paid by the applicant. Consequently, this international search report is restricted to the invention first mentioned in the claims; it is covered by claim numbers:

1-7

4.  As all searchable claims could be searched without effort justifying an additional fee, the International Searching Authority did not invite payment of any additional fee.

## Remark on Protest

The additional search fees were accompanied by applicant's protest.

No protest accompanied the payment of additional search fees.